

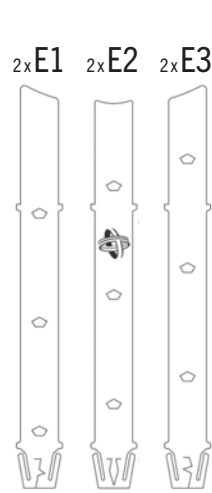

ASSEMBLY VIDEO
cutt.ly/crystal-twister-assembly

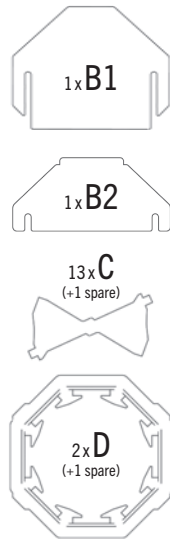

PREPARATION I
 Separate all parts. Use gloves

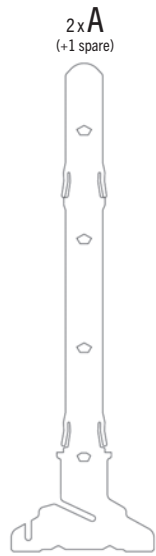

PREPARATION II
 Lay out all the necessary parts

1.

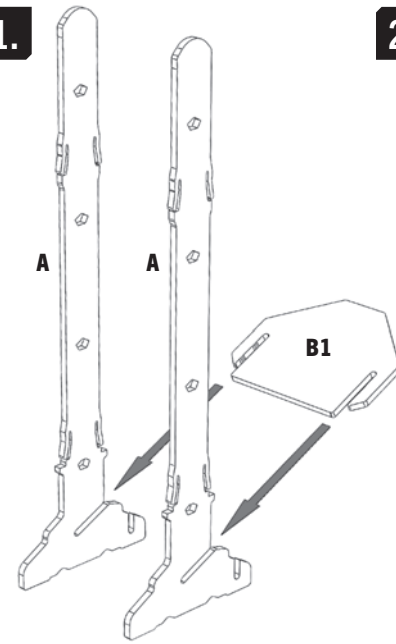

2.

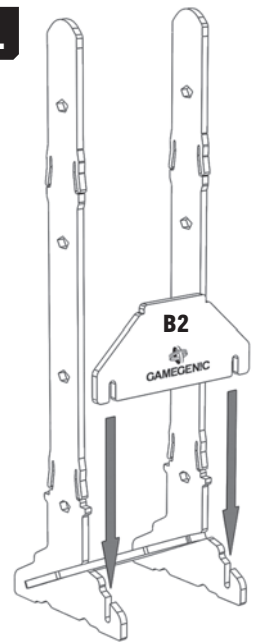

3.

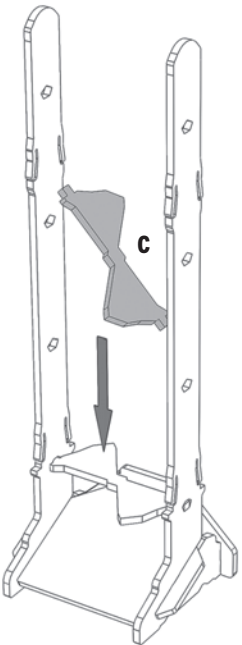

4.

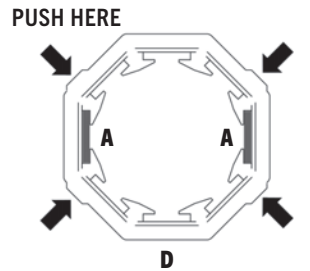
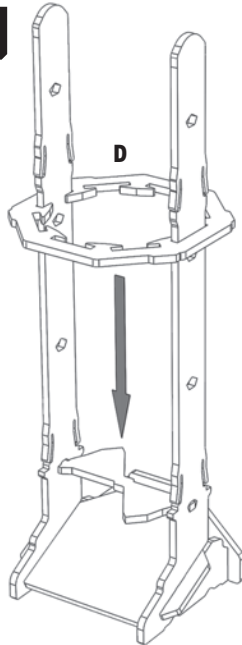

CORRECT POSITION: "CLICK!"

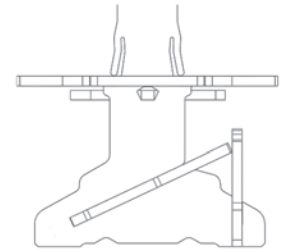

5.

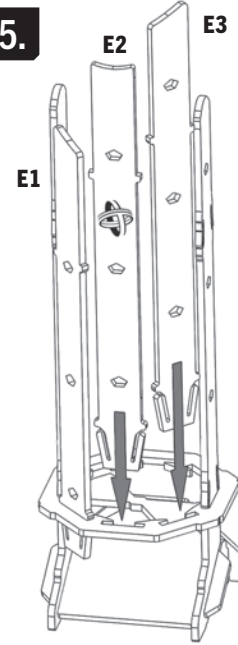

PICTOGRAMS HELP YOU TO PUT THE PIECES INTO THE RIGHT POSITIONS

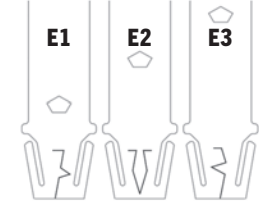

CORRECT STAIRS POSITION

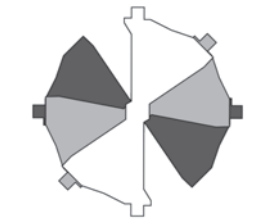

6.

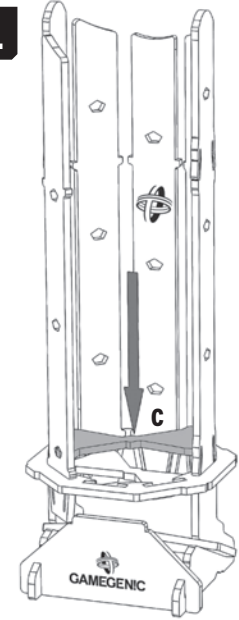

7.

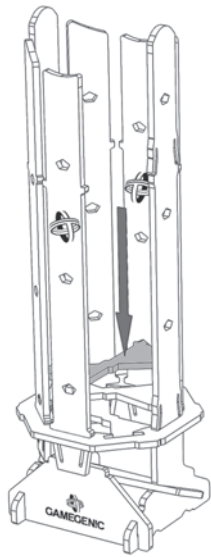

8.

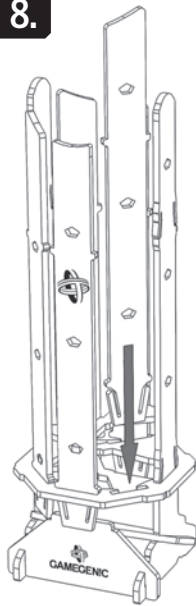

IT'S TIME TO USE A CROCODILE!

The crocodile helper can assist you to position the stairs inside the tower

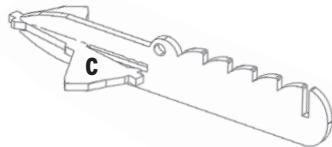

1. Fix a single stair in the clasp of the crocodile



JUMP TO THIS PART IN THE ASSEMBLY VIDEO
cutt.ly/crystal-twister-crocodile

9.

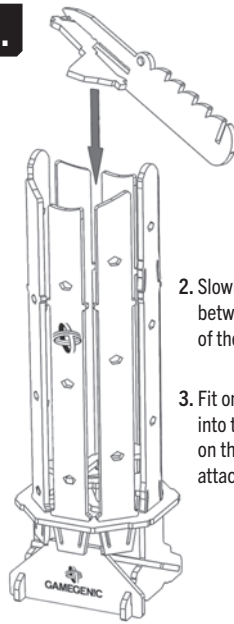

2. Slowly lead the stair down between the vertical walls of the tower

3. Fit one side of the stair into the connector on the wall and then attach the other side

10.

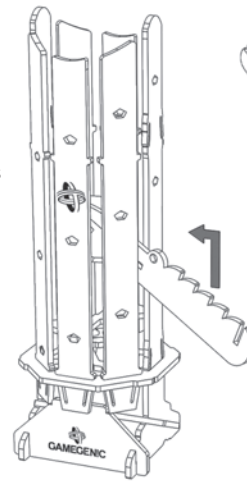

11.

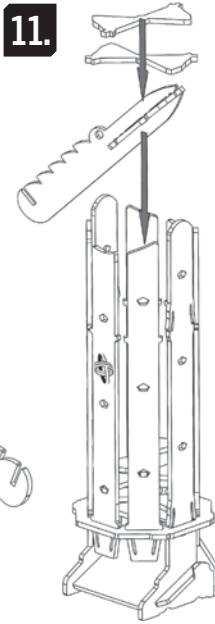

12.

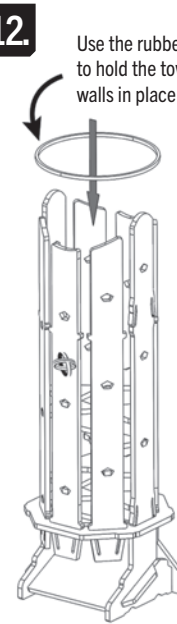

Use the rubber band to hold the tower's walls in place

13.

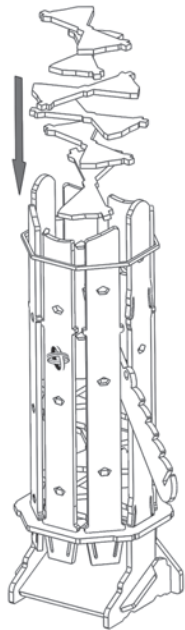

14.

PUSH VERY GENTLY

Parts may break if you push too hard!

Carefully slide the rubber band down

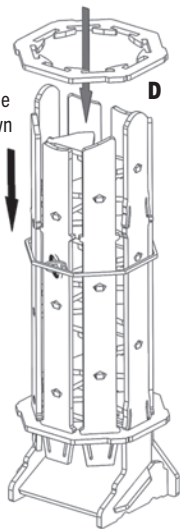

15.

Remove the rubber band

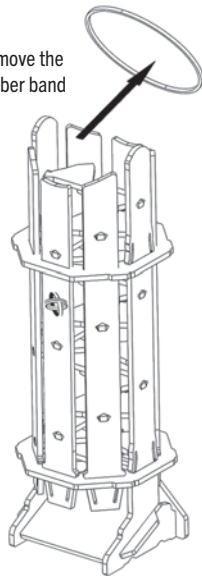

16.

1. →
2. →

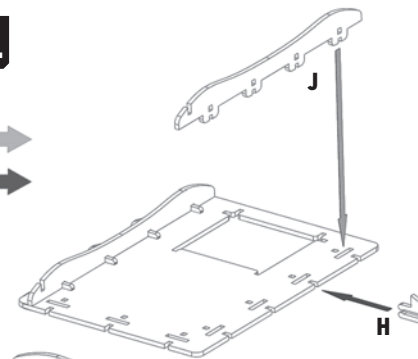

17.

